

Analog Devices Welcomes Hittite Microwave Corporation

NO CONTENT ON THE ATTACHED DOCUMENT HAS CHANGED



THIS PAGE INTENTIONALLY LEFT BLANK

Typical Applications

Low noise MMIC VCO w/Divide-by-8 for Ku-Band applications such as:

- Point-to-Point Radios
- Point-to-Multi-Point Radios / LMDS
- VSAT

Features

Pout: -7 dBm
 Phase Noise: -105 dBc/Hz @100 KHz Typ.
 No External Resonator Needed
 Single Supply: 5V @ 290 mA
 QSOP16G SMT Package

Functional Diagram

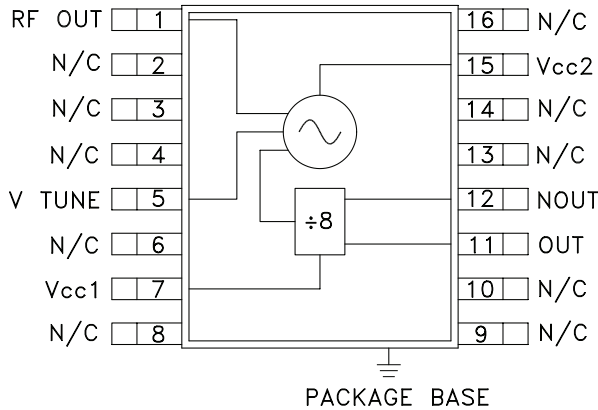

General Description

The HMC401QS16G & HMC401QS16GE are GaAs InGaP Heterojunction Bipolar Transistor (HBT) MMIC VCOs. The HMC401QS16G & HMC401QS16GE integrate resonators, negative resistance devices, varactor diodes and divide-by-8 prescalers. The VCO's phase noise performance is excellent over temperature, shock, and process due to the oscillator's monolithic structure. Power output is -7 dBm typical from a 5V supply voltage. The voltage controlled oscillator is packaged in a low cost, surface mount 16 leaded QSOP package with an exposed base for improved RF and thermal performance.

Electrical Specifications, $T_A = +25^\circ \text{C}$, $V_{cc1}, V_{cc2} = +5\text{V}$

Parameter	Min.	Typ.	Max.	Units
Frequency Range	13.2 - 13.5			GHz
Power Output	FR Output	-10	-7	dBm
	Divided Output	-9	-6	dBm
SSB Phase Noise @ 100 kHz Offset, $V_{tune} = +5\text{V}$ @ RF Output		-105		dBc/Hz
Tune Voltage	V_{tune}	0	10	V
Supply Current	I_{cc1} (Digital)	65		mA
	I_{cc2} (RF)	225		mA
Tune Port Leakage Current ($V_{tune} = 10\text{V}$)			10	μA
Output Return Loss		2		dB
Harmonics/Subharmonics	1/2	-7		dBc
	3/2	-28		dBc
	2nd	-17		dBc
	5/2	-40		dBc
Pulling (into a 2.0:1 VSWR)		0.6		MHz pp
Pushing @ $V_{tune} = 5\text{V}$		5		MHz/V
Frequency Drift Rate		1.5		MHz/ $^\circ\text{C}$

Frequency vs. Tuning Voltage, $T = 25^{\circ}\text{C}$

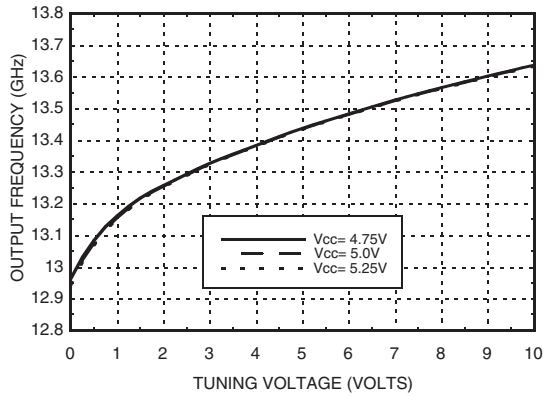

Frequency vs. Tuning Voltage, $V_{cc} = +5V$

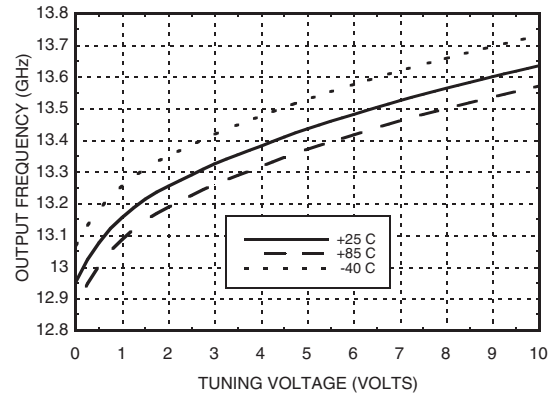

Sensitivity vs. Tuning Voltage, $V_{cc} = +5V$

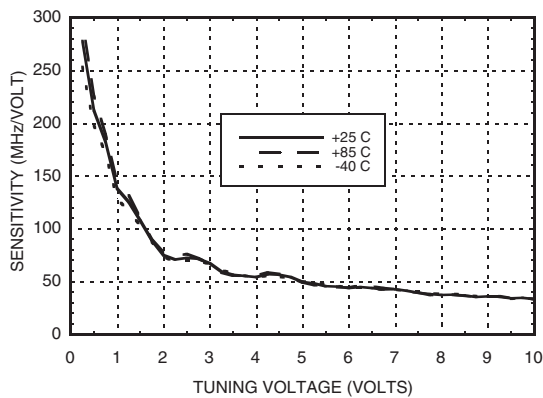

Output Power vs. Tuning Voltage, $V_{cc} = +5V$

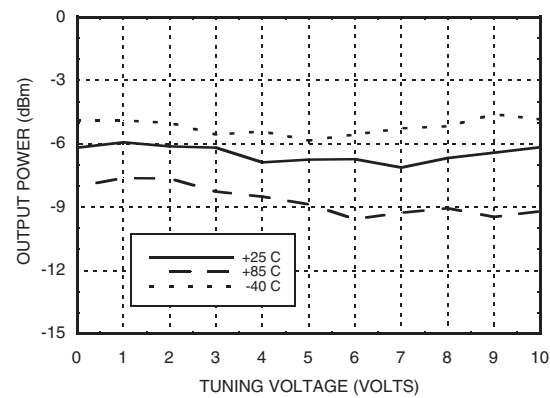

SSB Phase Noise vs. Tuning Voltage

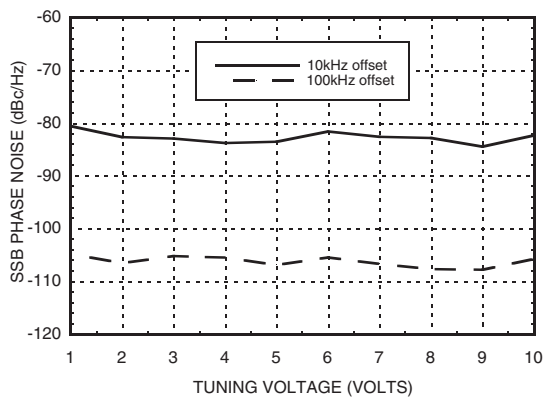

Phase Noise @ $V_{tune} = 5V$

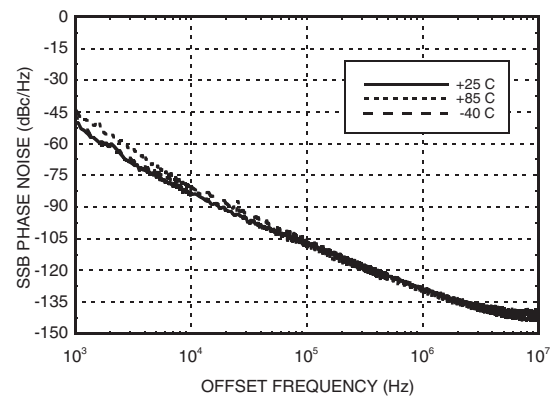



Divided Frequency vs. Tuning Voltage, Vcc= +5V

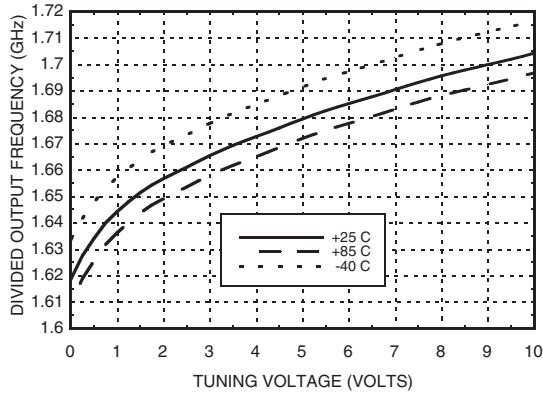

Divided Output Power vs. Tuning Voltage, Vcc= +5V

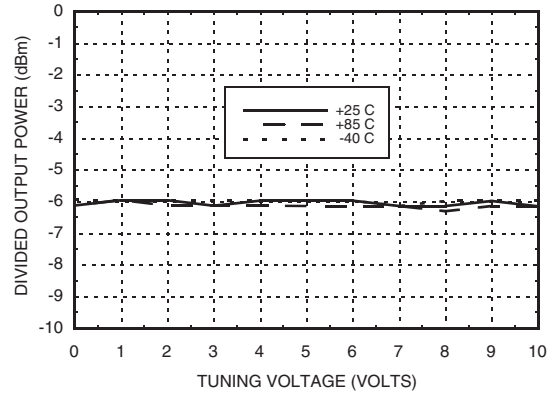

Divided Output SSB Phase Noise @ Vtune= 5V

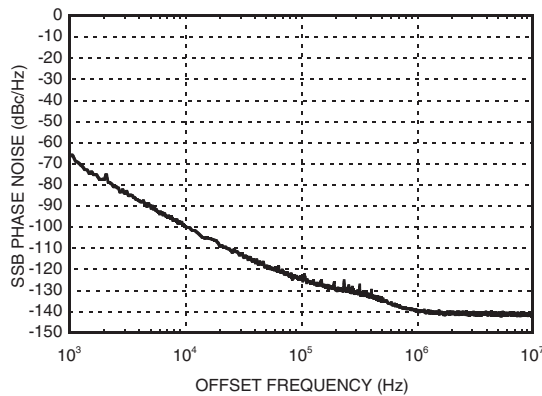

Absolute Maximum Ratings

Vcc1, Vcc2	5.5 V
Storage Temperature	-65 to +150 °C
Operating Temperature	-40 to +85 °C
Vtune	0 to 11V Max.
ESD Sensitivity (HBM)	Class 1A

Typical Supply Current vs. Vcc

Vcc (V)	Icc (mA)
4.75	260
5.0	290
5.25	315

Note: VCO will operate over full voltage range shown above.



**ELECTROSTATIC SENSITIVE DEVICE
OBSERVE HANDLING PRECAUTIONS**

Outline Drawing

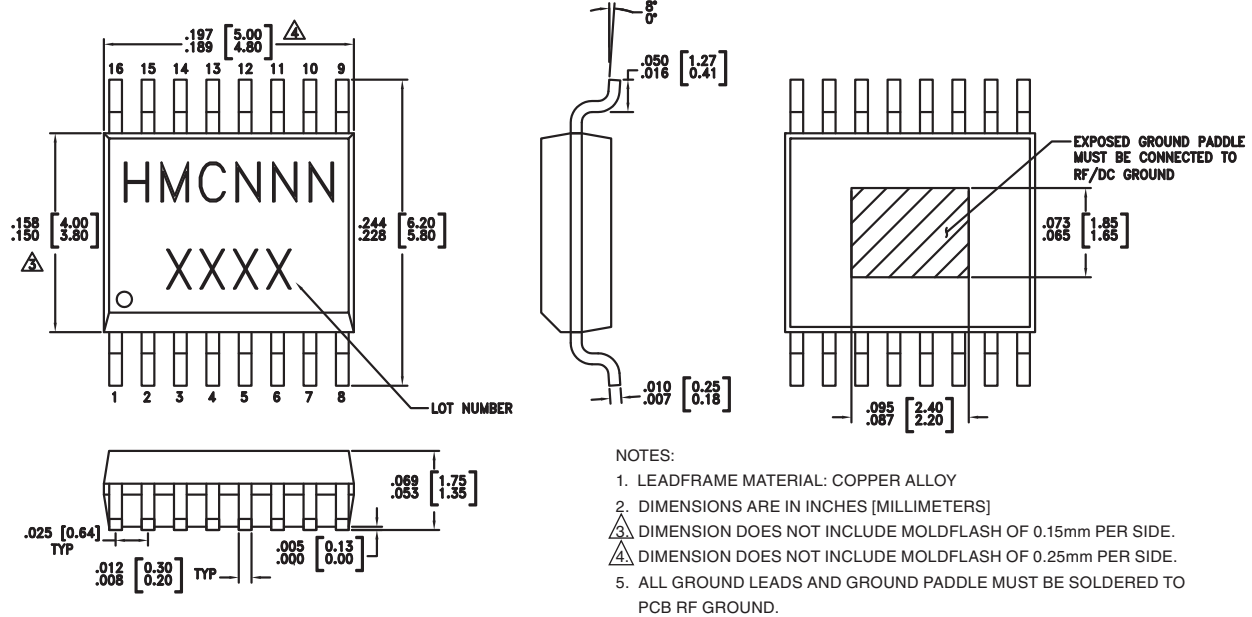

Package Information



Part Number	Package Body Material	Lead Finish	MSL Rating	Package Marking ^[3]
HMC401QS16G	Low Stress Injection Molded Plastic	Sn/Pb Solder	MSL1 ^[1]	HMC401 XXXX
HMC401QS16GE	RoHS-compliant Low Stress Injection Molded Plastic	100% matte Sn	MSL1 ^[2]	HMC401 XXXX

[1] Max peak reflow temperature of 235 °C
 [2] Max peak reflow temperature of 260 °C
 [3] 4-Digit lot number XXXX

Pin Descriptions

Pin Number	Function	Description	Interface Schematic
1	RFOUT	RF output (AC coupled).	
2, 3, 4, 6, 8, 9, 10, 13, 14, 16	N/C	No Connection	
5	VTUNE	Control Voltage Input. Modulation port bandwidth dependent on drive source impedance.	

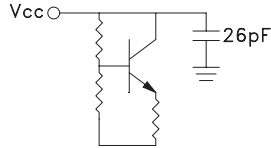
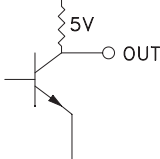
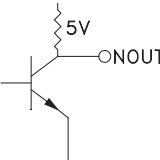
Pin Descriptions

Pin Number	Function	Description	Interface Schematic
7, 15	VCC1, VCC2	Supply Voltage, 5V	
11	OUT	Divided Output	
12	NOUT	Divided Output 180° output phase with pin 11.	
	GND	Package bottom has an exposed metal paddle that must be RF & DC grounded.	

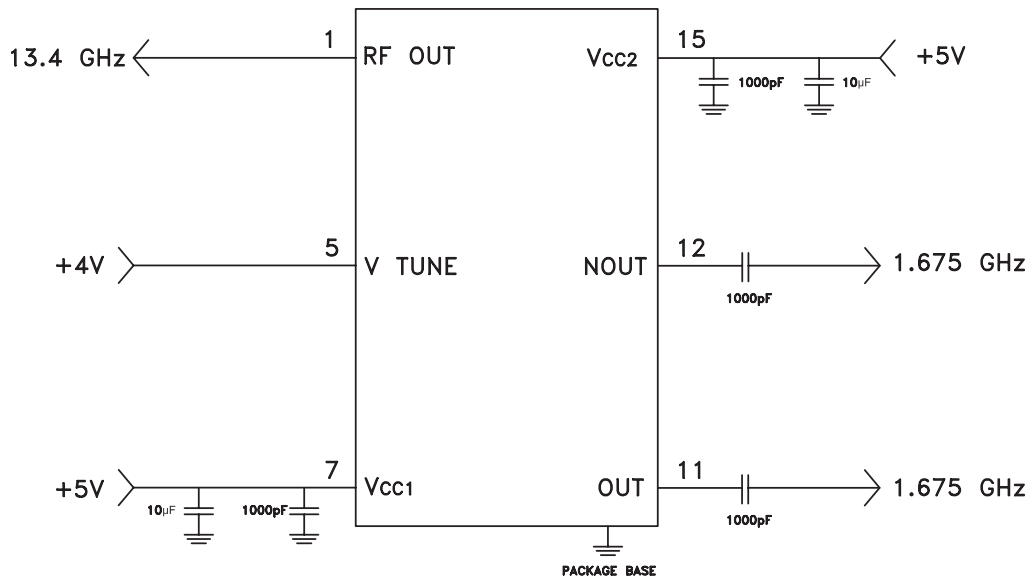
Typical Application Circuit

Evaluation PCB

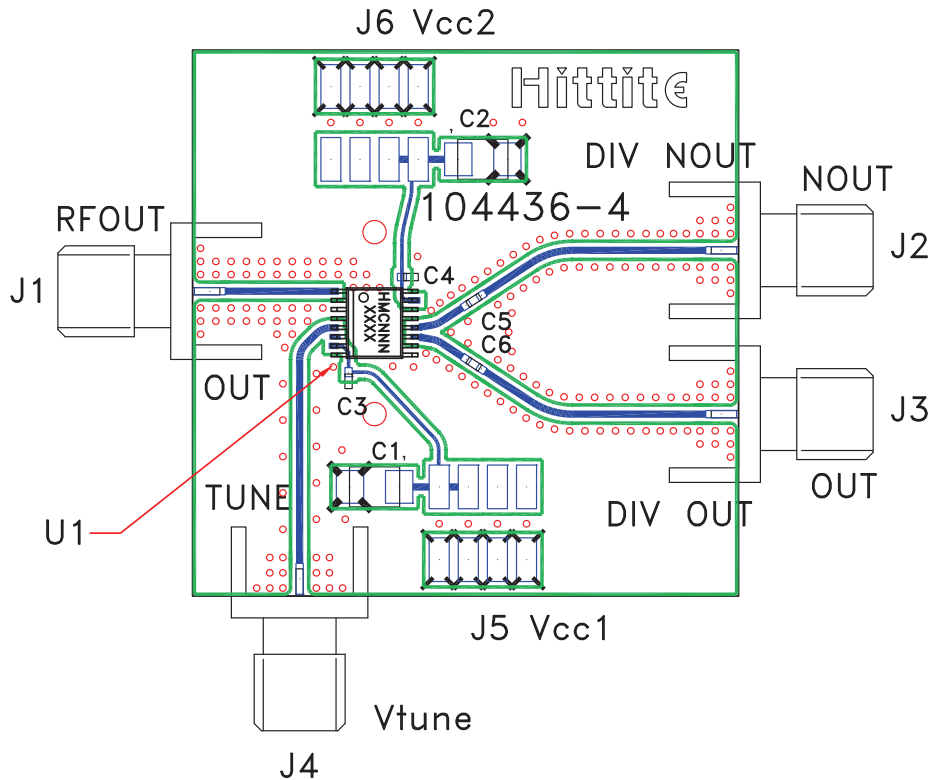

List of Materials for Evaluation PCB 104711 [1]

Item	Description
J1 - J4	PCB Mount SMA RF Connector
J5 - J6	2 mm DC Header
C1 - C2	10 μ F Tantalum Capacitor
C3 - C6	1,000 pF Capacitor, 0402 Pkg.
U1	HMC401QS16G / HMC401QS16GE VCO
PCB [2]	104436 Eval Board

[1] Reference this number when ordering complete evaluation PCB

[2] Circuit Board Material: Rogers 4350

The circuit board used in the application should use RF circuit design techniques. Signal lines should have 50 Ohm impedance while the package ground leads and backside ground slug should be connected directly to the ground plane similar to that shown. A sufficient number of via holes should be used to connect the top and bottom ground planes. The evaluation circuit board shown is available from Hittite upon request.